

# STUCKI

Küche | Bad | Wohnen

Bad Nr. 4 Anthrazit / Rot



# Grundriss

Ansicht Bad Nr. 4

1C  
Regal

Seitenriss

Eku Regal B 25 SP Vorfront (VF)

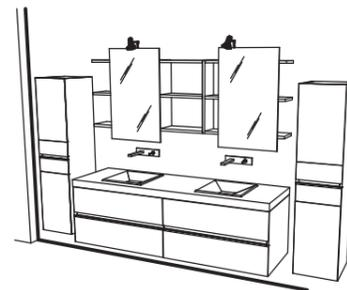
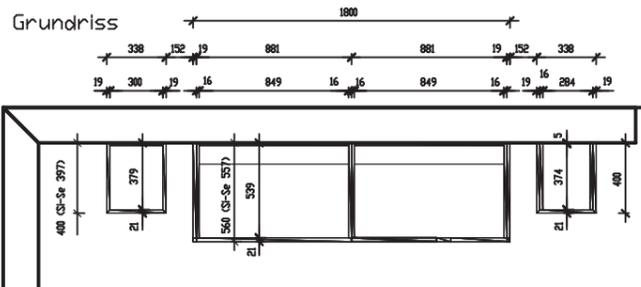
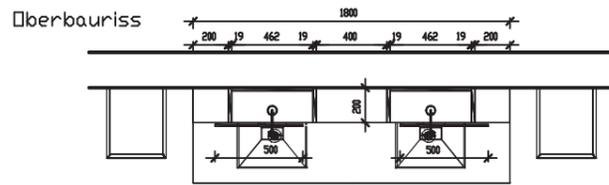
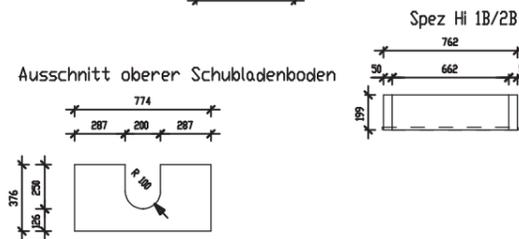
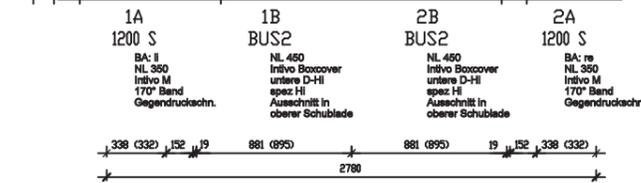
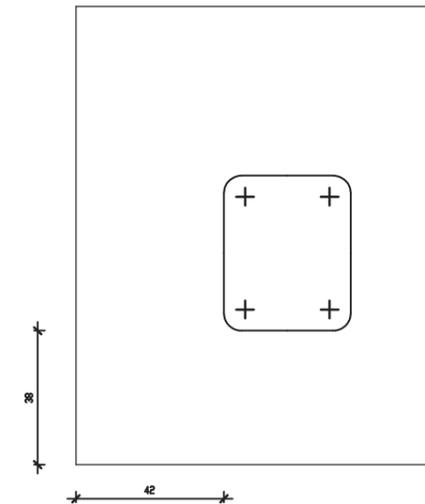
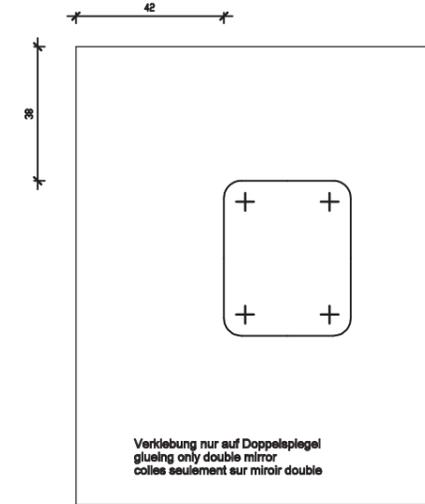
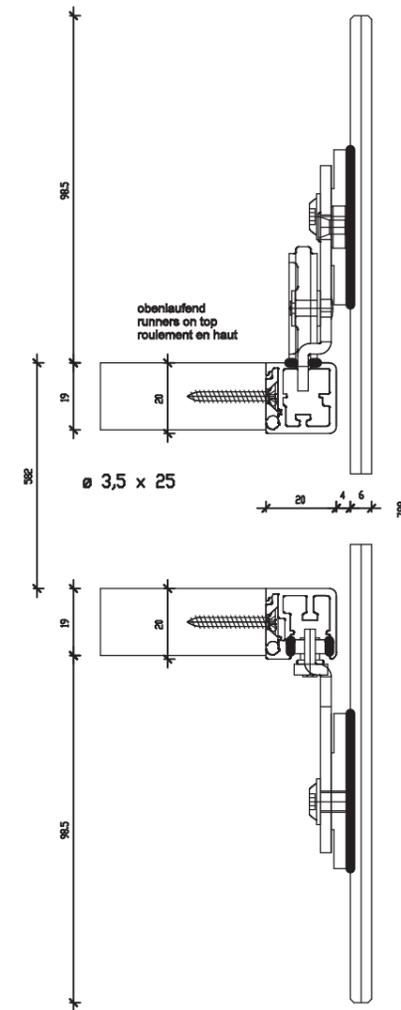
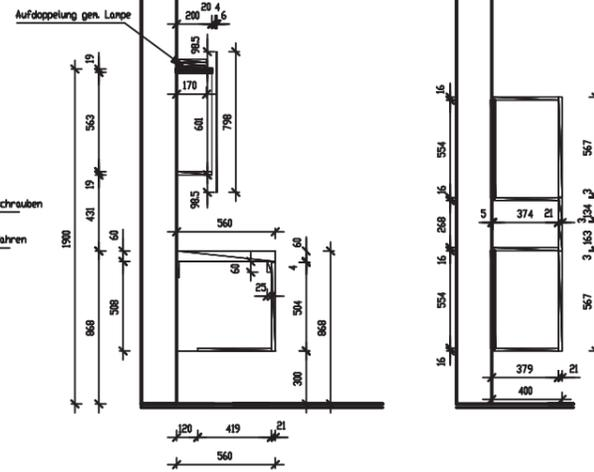
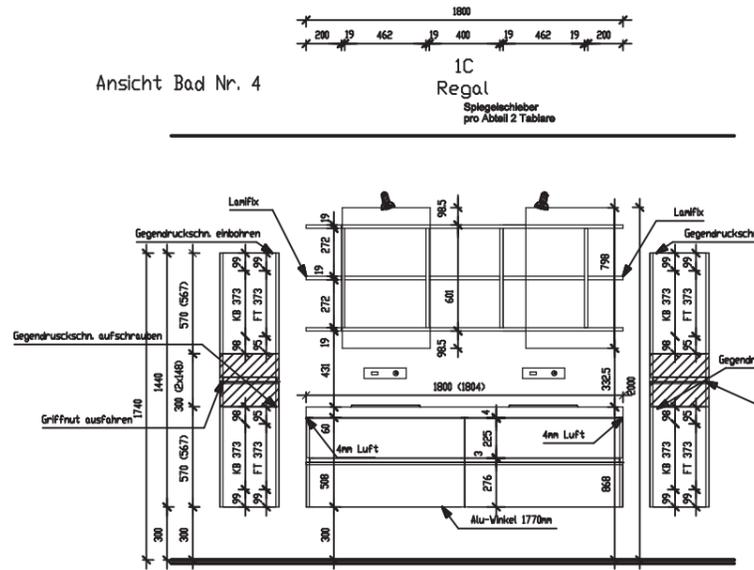

Schiebebeschläge:  
2x Schiebegerätemit Opo 51.071.03  
2x Laufschiene Opo 51.071.15  
2x Führungsschiene Opo 51.071.18  
2x Zwischenstopper Opo 51.071.21

Aufdoppelung Licht

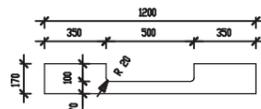

Ausführung

Fronten:  
MDF mit GF, halbmatt lackiert, RAL 7021 Anthrazit metallic

MDF mit GF, glanz lackiert, RAL 3003 Rubinrot

Kanten:  
2mm gerundet

Griffe:  
Norm-Griffnut in MDF gefräst

Abdeckung:  
Corian Pure White

Becken:  
Alape EB.KF 400

Mischer:

KUNDE: Stucki Küchen AG  
Worbstrasse 85, CH-3075 Rüfenacht  
PROJEKT: Ausstellungsbad Nr. 4 Anthrazit / Rot / Corian

AUFTRAG: 106023.01

DATEI: Bad neu  
GEZ.: lorenz.furrer  
MST.: 1:20

Datum: 15.07.2021  
Rev.: 08.12.2021

**STUCKI**  
KÜCHE ■ BAD ■ WOHNEN

Stucki Küchen AG - Worbstrasse 85 - 3075 Rüfenacht - Telefon 031 839 33 66 - office@stucki-kuechen.ch - www.stucki-kuechen.ch